



**INTEX**<sup>®</sup>  
MILLWORK SOLUTIONS

**Outdoor Living  
2019**



**INTEX**<sup>®</sup>  
MILLWORK SOLUTIONS

## *When Only The Best Will Do*

### **Low Maintenance**

INTEX Millwork's products are easier to maintain than traditional wood millwork – they don't warp, rot, or degrade, making them truly timeless solutions.

### **Unparalleled Service**

We work with architects, builders, dealers, and homeowners to ensure every expectation is met, every time. Our team is committed to getting it right, down to the very last detail.

### **Exceptional Expertise**

Our INTEX experts have spent decades constructing intricately-engineered exterior elements that will take any home to the next level.

## *The INTEX Difference*

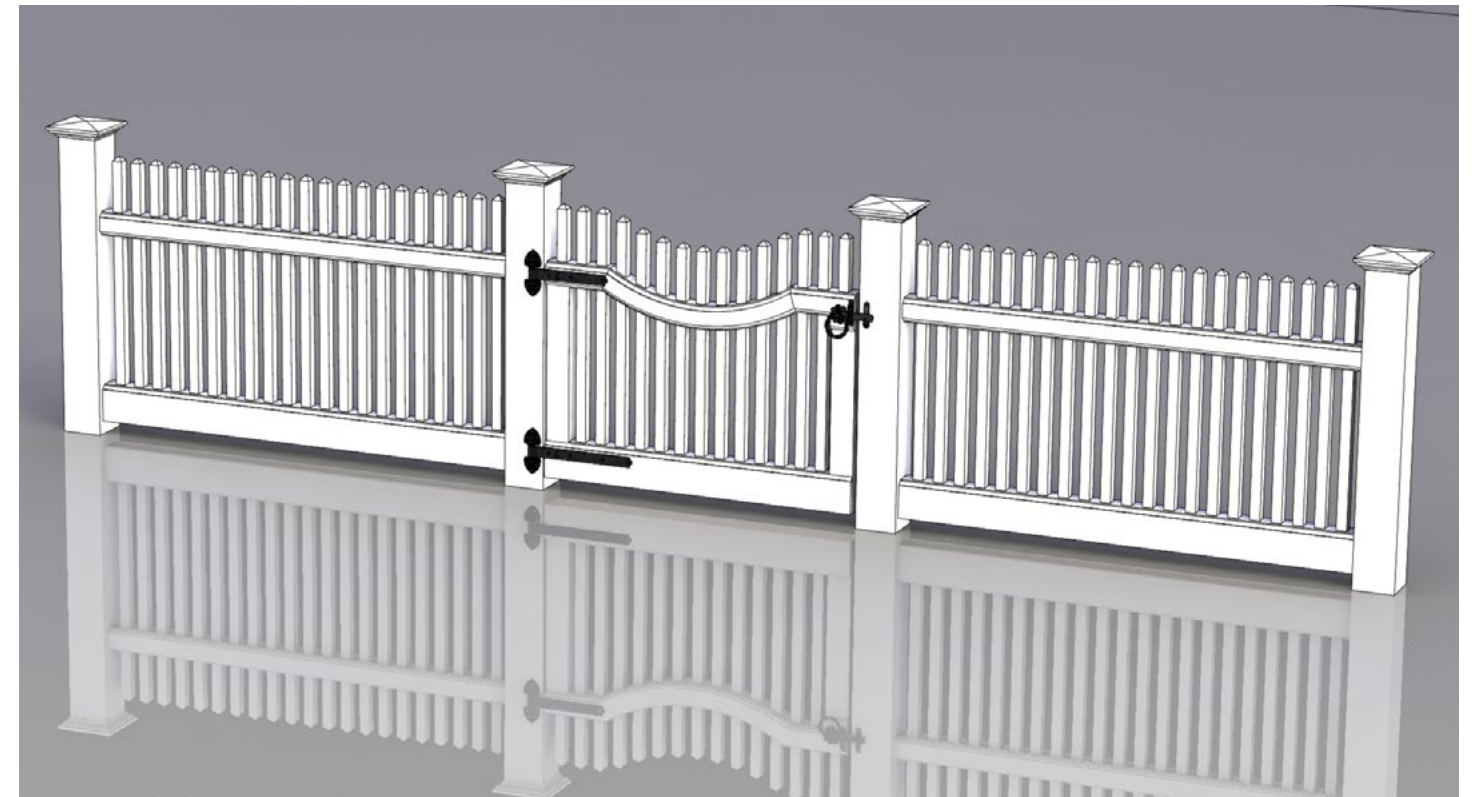

By partnering with INTEX Millwork, architects, designers and contractors can deliver on each and every project, from the very basic to the most complex.

Dedicated to bringing that old-world touch to newly constructed custom homes, maintaining the beauty of historical remodels with the latest innovations in materials and techniques, and just about everything in between, INTEX

Millwork has a solution that effortlessly meets the exterior needs of architects, designers, and contractors, every single time.

A family owned company, INTEX Millwork is a loyal and attentive business partner who fully understands the building cycle and supports the use of their products at every stage of the process, from a customer's first inquiry through the installation.

*The finishing touch that stands the test of time.*



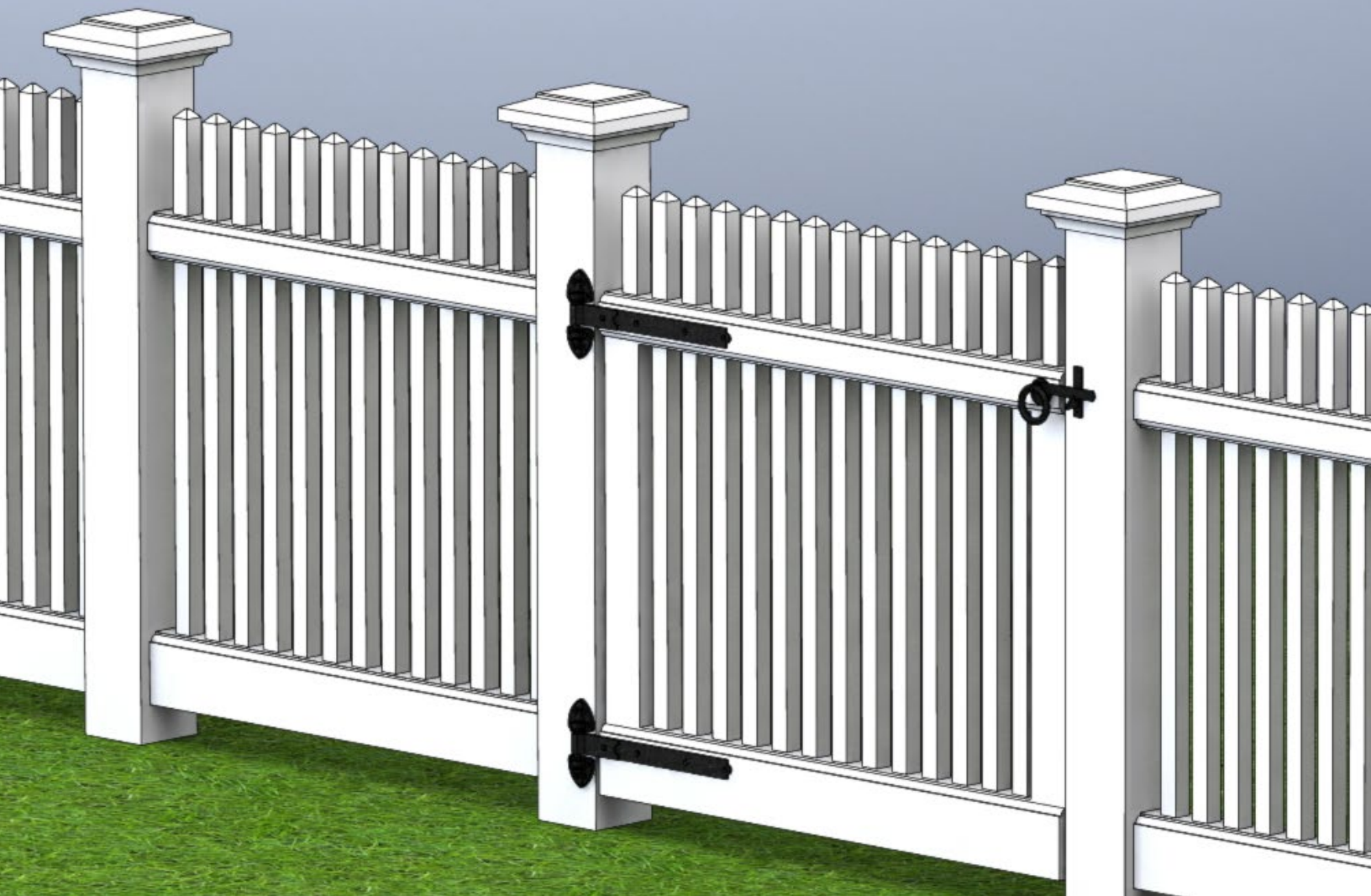

## Ease of Installation

*The Estate Series boasts prominent profile features with a simple drop-together installation with minimal on-site tool requirements and hidden fasteners.*

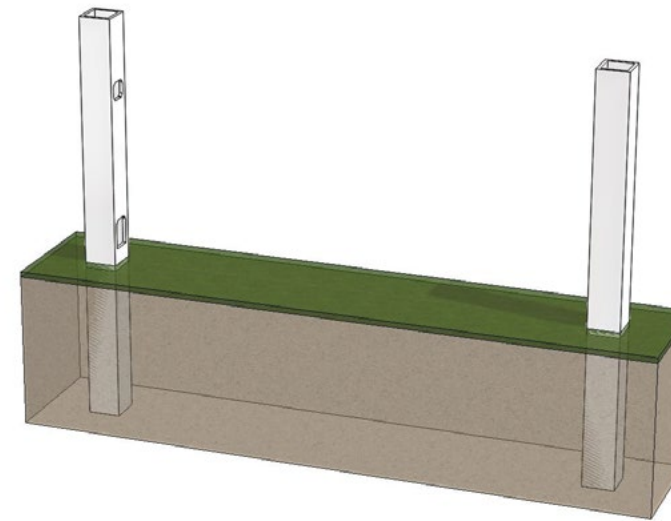

**STEP 1:** Install posts.

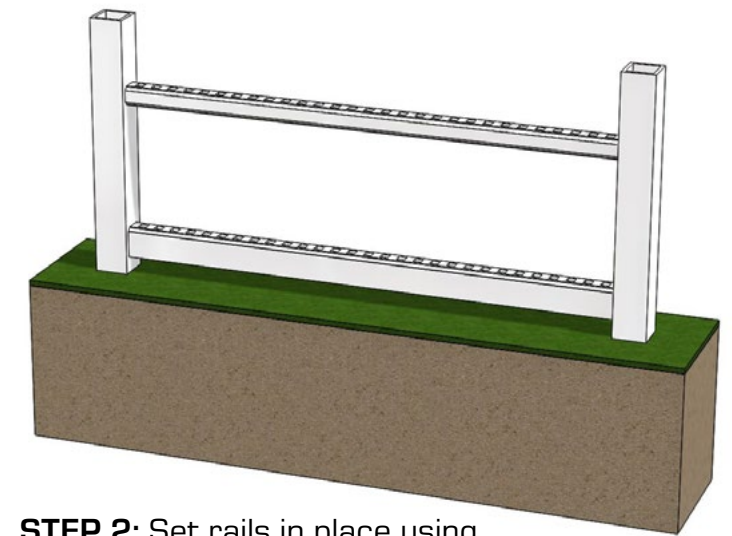

**STEP 2:** Set rails in place using pre-routed post mortises.

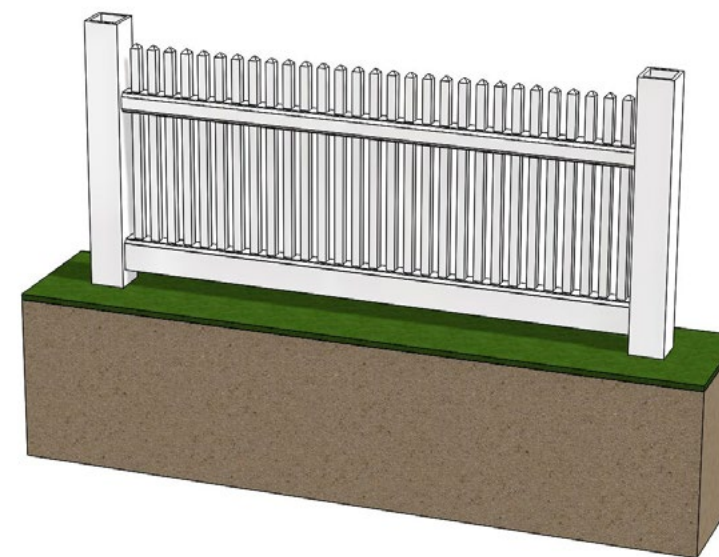

**STEP 3:** Snap pickets into place.

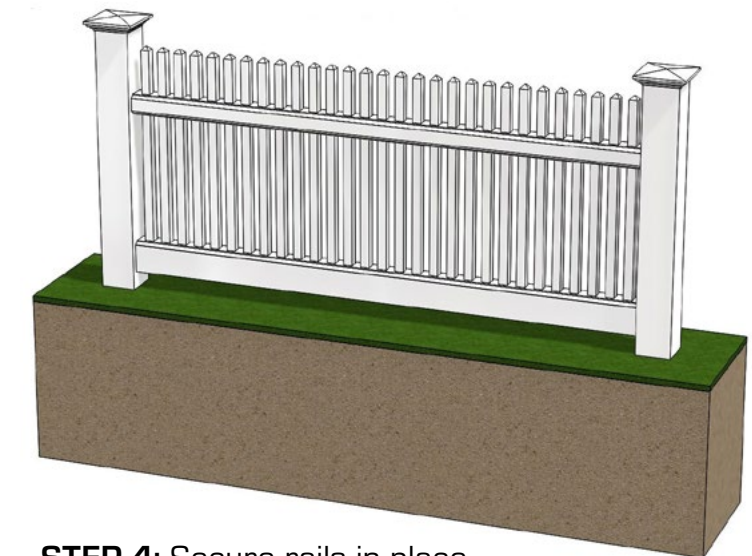

**STEP 4:** Secure rails in place.

# Estate

## FENCE SERIES

*Represents INTEX's best in style, design, and ease of installation in its fence product line offering.*

- 100% Cellular PVC
- Available in a Variety of Styles and Sizes
- Reinforced Aluminum Core for Strength & Corrosion Resistance
- Gates Structurally Reinforced with Welded Frame
- Aesthetically Pleasing Shadow Lines
- Rackable or Stepped for Grade Adjustment
- Low Maintenance and Easy to Clean
- Does Not Require Paint, but Can Be Painted (LRV Greater Than 55)
- For Pricing Information Visit [intexmillwork.com](http://intexmillwork.com)

# Fence Dimensions

**Standard Lengths** or runs of fence available are 4', 6', and 8'. This dimension is specified from post centers, so the exposed spans are 6" less.

**Standard Heights** of fence available are 3', 3-1/2', 4', and 5'. This dimension is from the ground to the top of the picket and is designed at 1" taller than specified. This allows the fence to be installed 1" lower and still reach at least the specified height.

**Standard Styles** of fence are available in any combination of span and height. Custom patterns can be achieved by installing pickets of varying length.

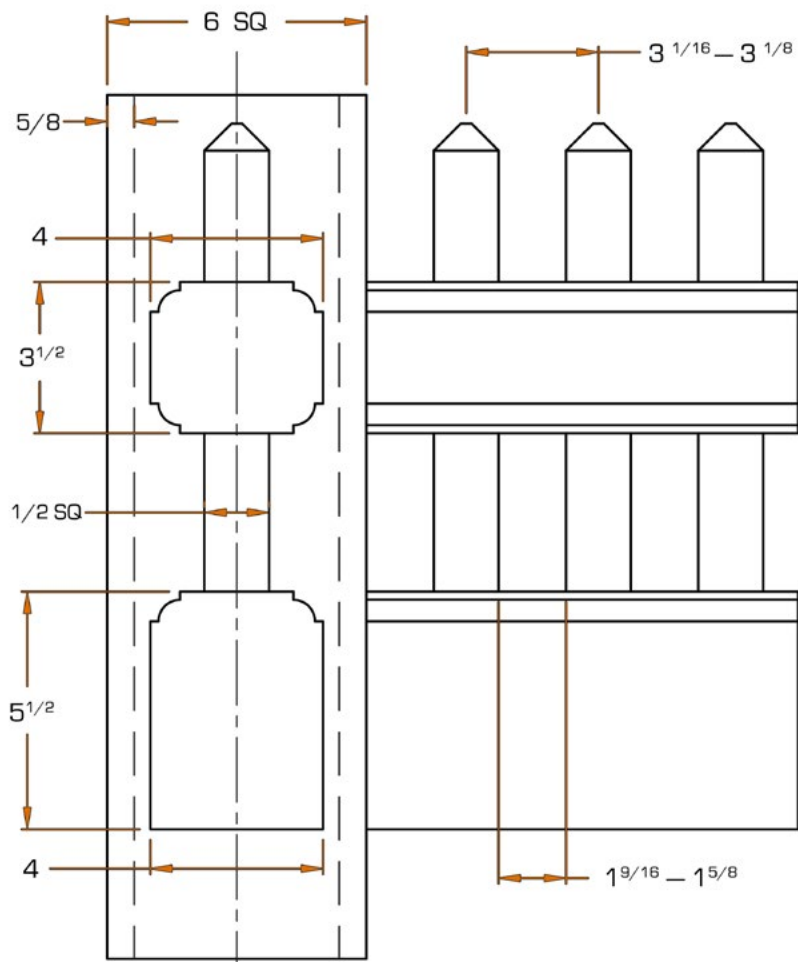

The fence system is modeled around the following overall dimensions:

Top Rail Cross Section	4" W x 3-1/2"H
Bottom Rail Cross Section	4" W x 5-1/2"H
Post Cross Section	6" Square, 5/8" Wall
Picket Cross Section	1-1/2" Square
Picket Spacing (Centers)	3-1/16" to 3-1/8"
Picket Spacing (Gaps)	1-9/16" to 1-5/8"

**INTERESTED IN PURCHASING INTEX PRODUCTS?**

Go to [www.intexmillwork.com](http://www.intexmillwork.com) to find an authorized dealer near you!



FIND US ON YOUR FAVORITE CHANNELS  
@intexmillwork | #intexmillwork

# Fence Dimensions

	F Opening	G Rail Length	H Post Centers	J Picket Center Spacing	K No. of Pickets	
Fence Spans	4'	42"	45-1/2"	48"	3-1/8"	13
	6'	66"	69-1/2"	72"	3-1/16"	21
	8'	90"	93-1/2"	96"	3-1/16"	29

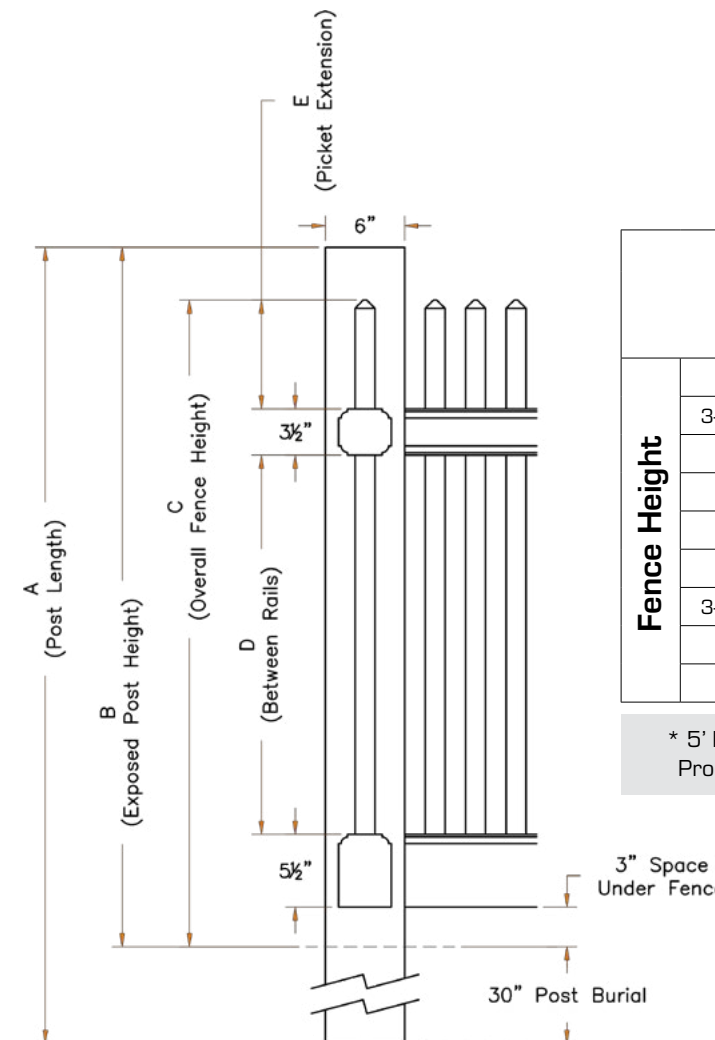
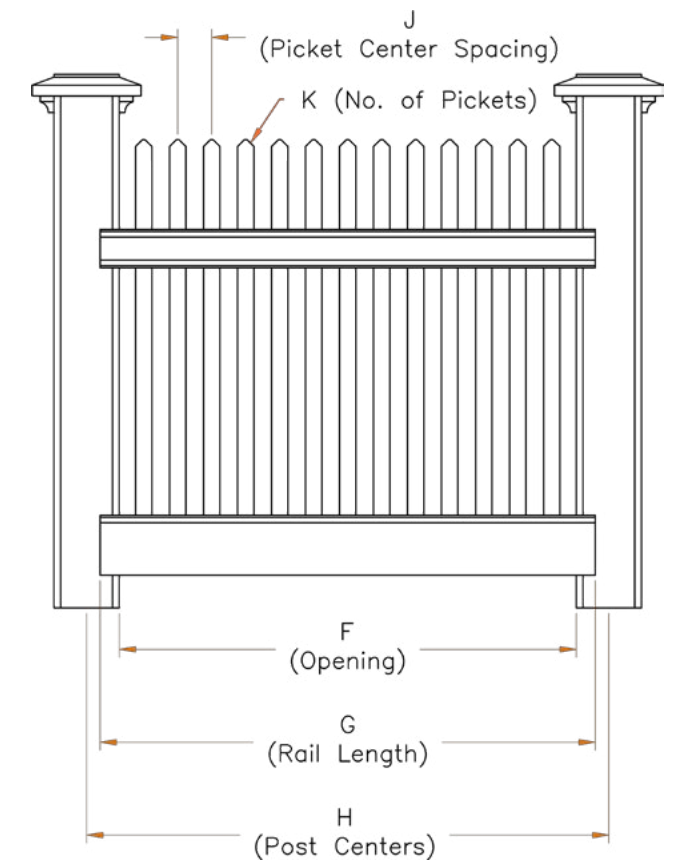

Fence Height	For Fence Styles 1 & 2					
	A Post Length	B Exposed Post Height	C Overall Fence Height	D Between Rails	E Picket Extension	
3'	71"	41"	37"	16-3/4"	8-1/4" Max	
3-1/2'	77"	47"	43"	22-3/4"	8-1/4" Max	
4'	83"	53"	49"	28-3/4"	8-1/4" Max	
5'	95"	65"	61"	41-3/4" *	7-1/4" Max	
Fence Height	For Fence Styles 3 & 4					
	3'	71"	41"	37"	10-3/4"	14-1/4" Max
	3-1/2'	77"	47"	43"	16-3/4"	14-1/4" Max
	4'	83"	53"	49"	22-3/4"	14-1/4" Max
5'	95"	65"	61"	34-3/4"	14-1/4" Max	

\* 5' High S1 / S2 Fence dimensions designed to comply with U.S. Consumer Product Safety Commission Safety Barrier Guidelines for Residential Pools



FENCE SECTION STYLES

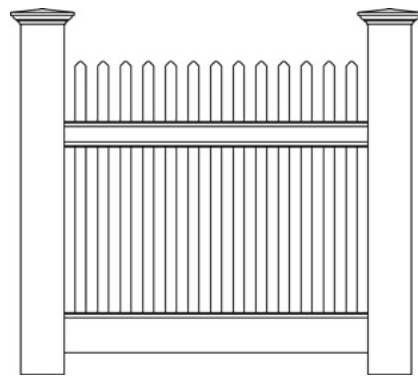

Style 1

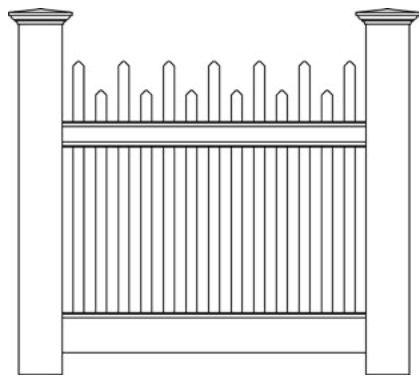

Style 2

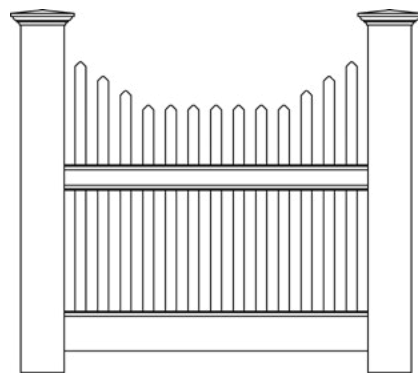

Style 3

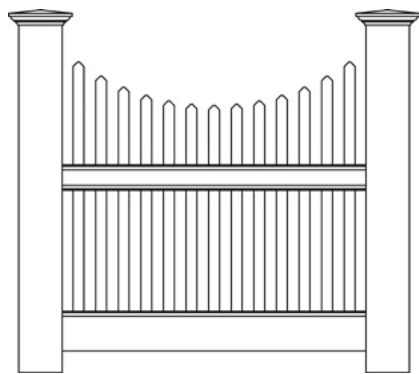

Style 4

GATE STYLES

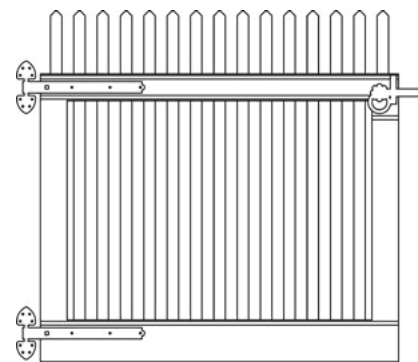

Style G1

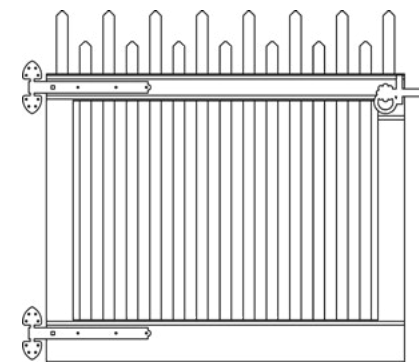

Style G2

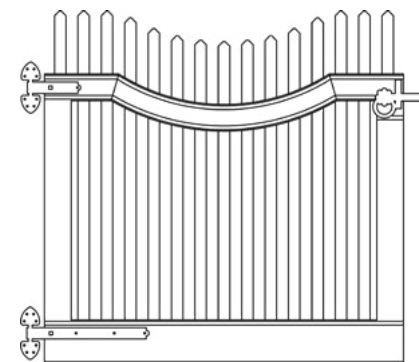

Style G3

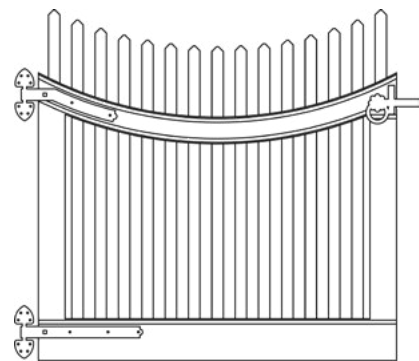

Style G4

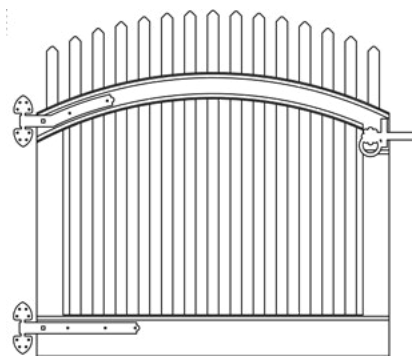

Style G5

Style Options

The Estate Series is available in four unique styles for fence section, and five styles for gates. Custom styles are also available by request.

All standard Gate Styles are also available as Double-Swing Gates.

Exceptional Strength

Fence Sections are aluminum reinforced for exceptional stability and strength. Gates are structurally reinforced with welded frames.

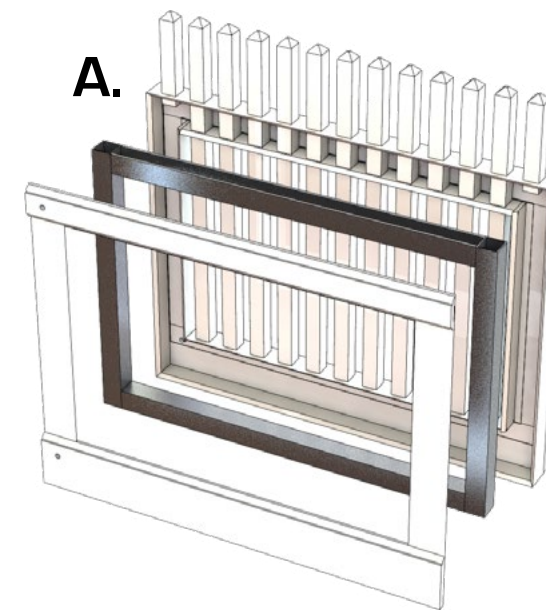

- A. Exploded view of the structurally reinforced gate.
- B. View of the aluminum reinforced top and bottom rails for fence sections.
- C. Two part post reinforcement for applications including gates, in-line reinforcement, and masonry or hard substrate mounting.

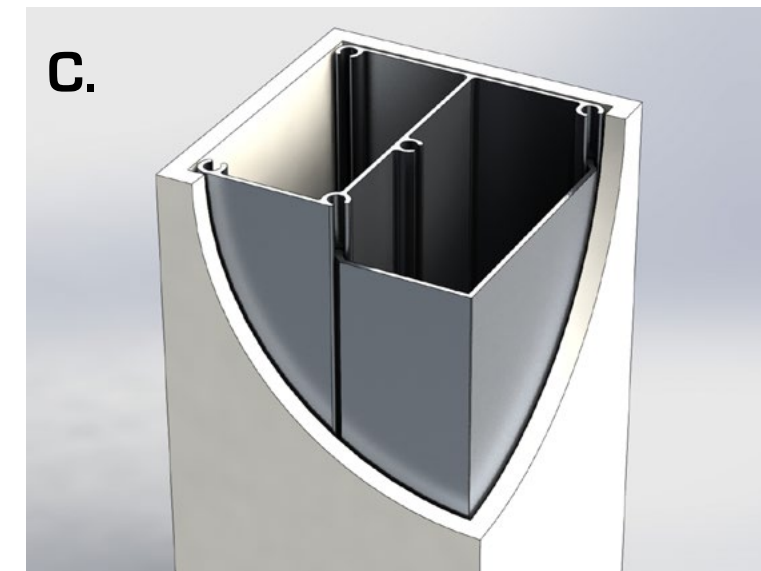
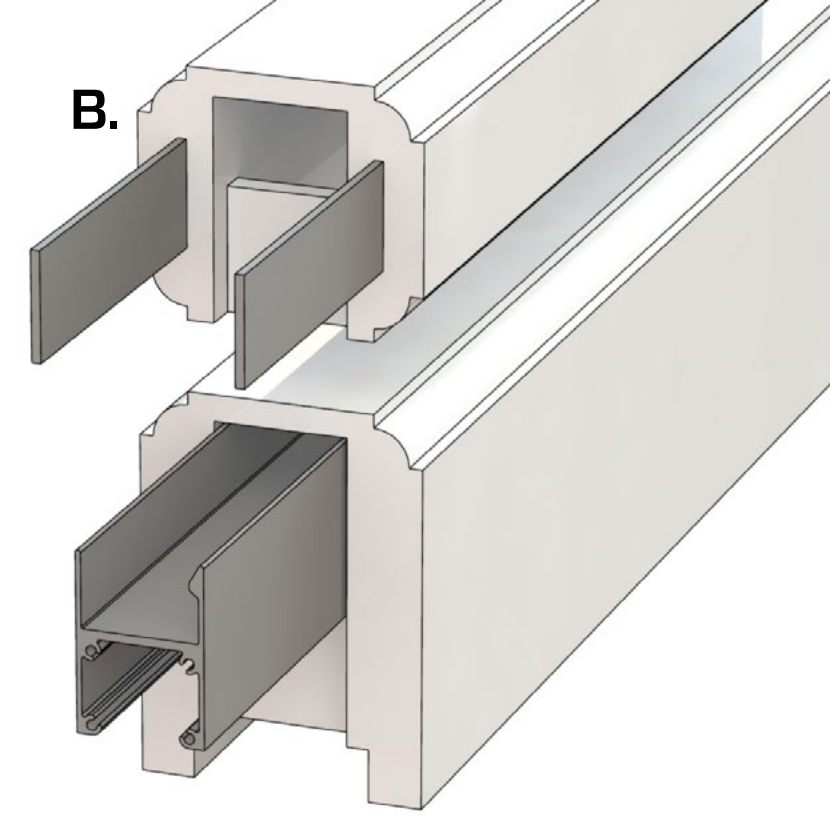

Components

ESTATE SERIES

- 1. Top & Bottom Rails
- 2. Pickets
- 3. Posts
- 4. Post Caps
- 5. Gates
- 6. Hardware/Accessories

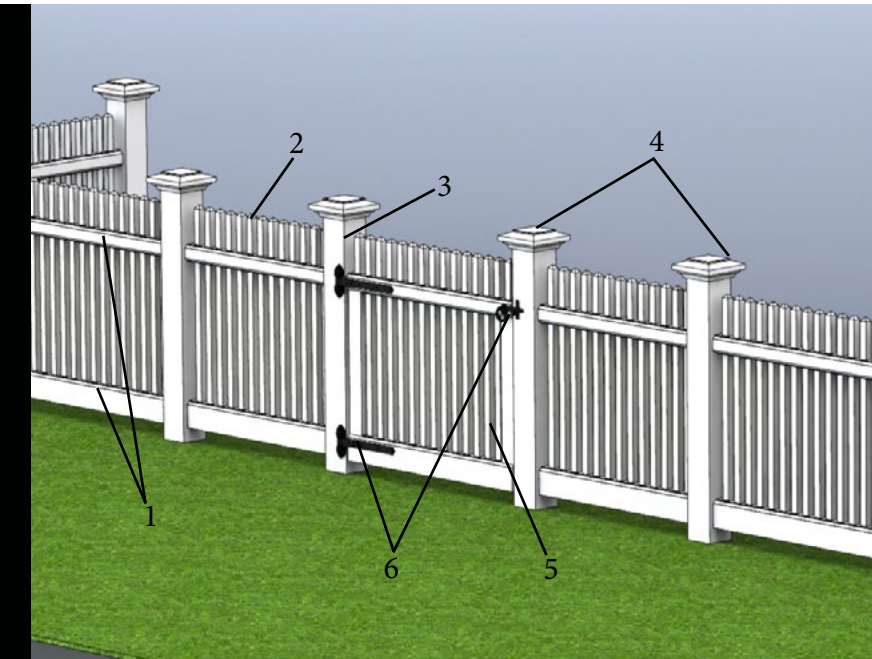



## STANDARD RACK

To allow for changes in grade, standard fence sections can be racked up to a 6" rise over an 8' span.

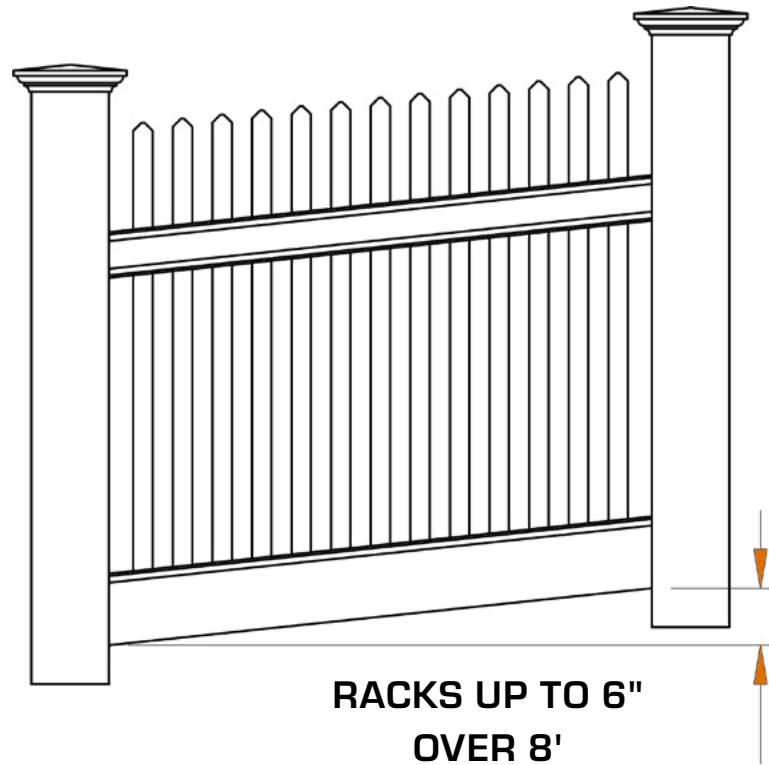

RACKS UP TO 6"  
OVER 8'

INTERESTED IN PURCHASING INTEX PRODUCTS?

Go to [www.intexmillwork.com](http://www.intexmillwork.com) to find an authorized dealer near you!



FIND US ON YOUR FAVORITE CHANNELS  
@intexmillwork | #intexmillwork

## ADJUSTABLE POST FOR STEPPED FENCE

If stepped level sections are preferred, an Adjustable Post (pictured below, left) is available with a mortised movable side that can be positioned as necessary.

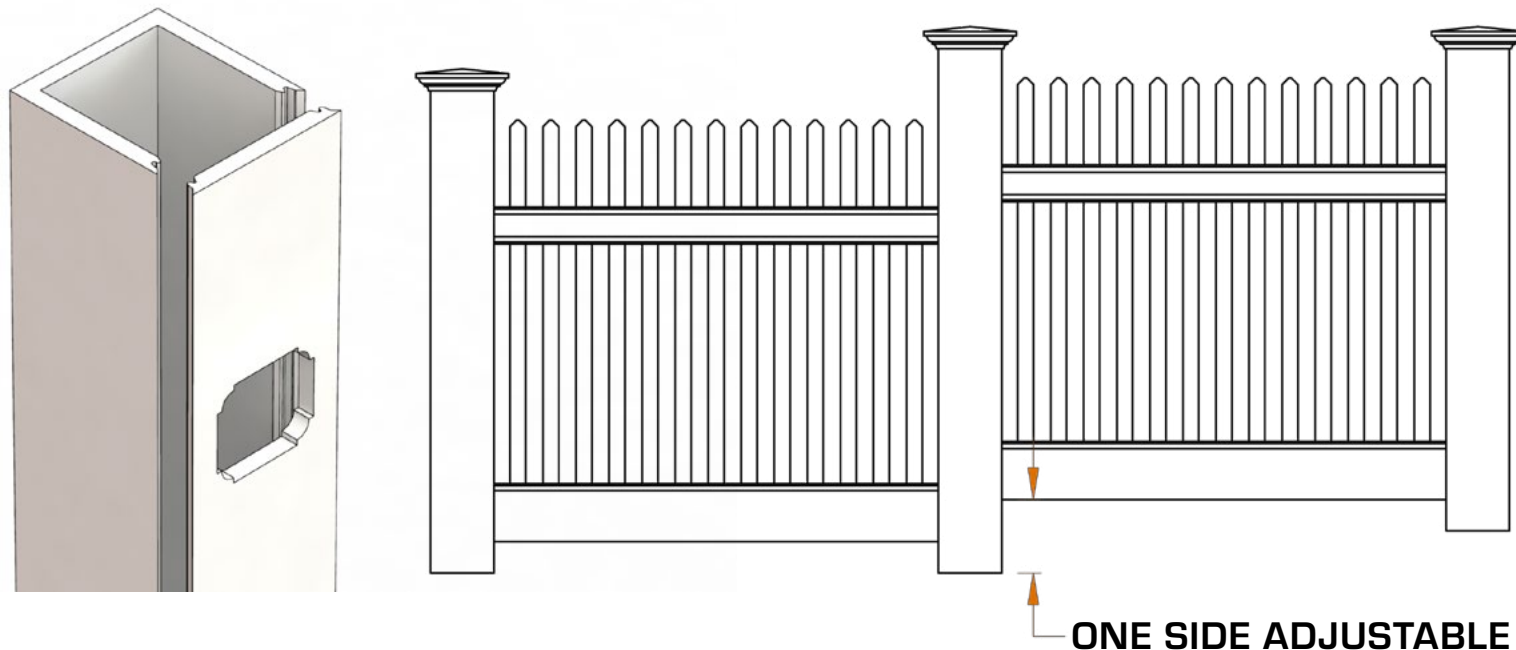

ONE SIDE ADJUSTABLE

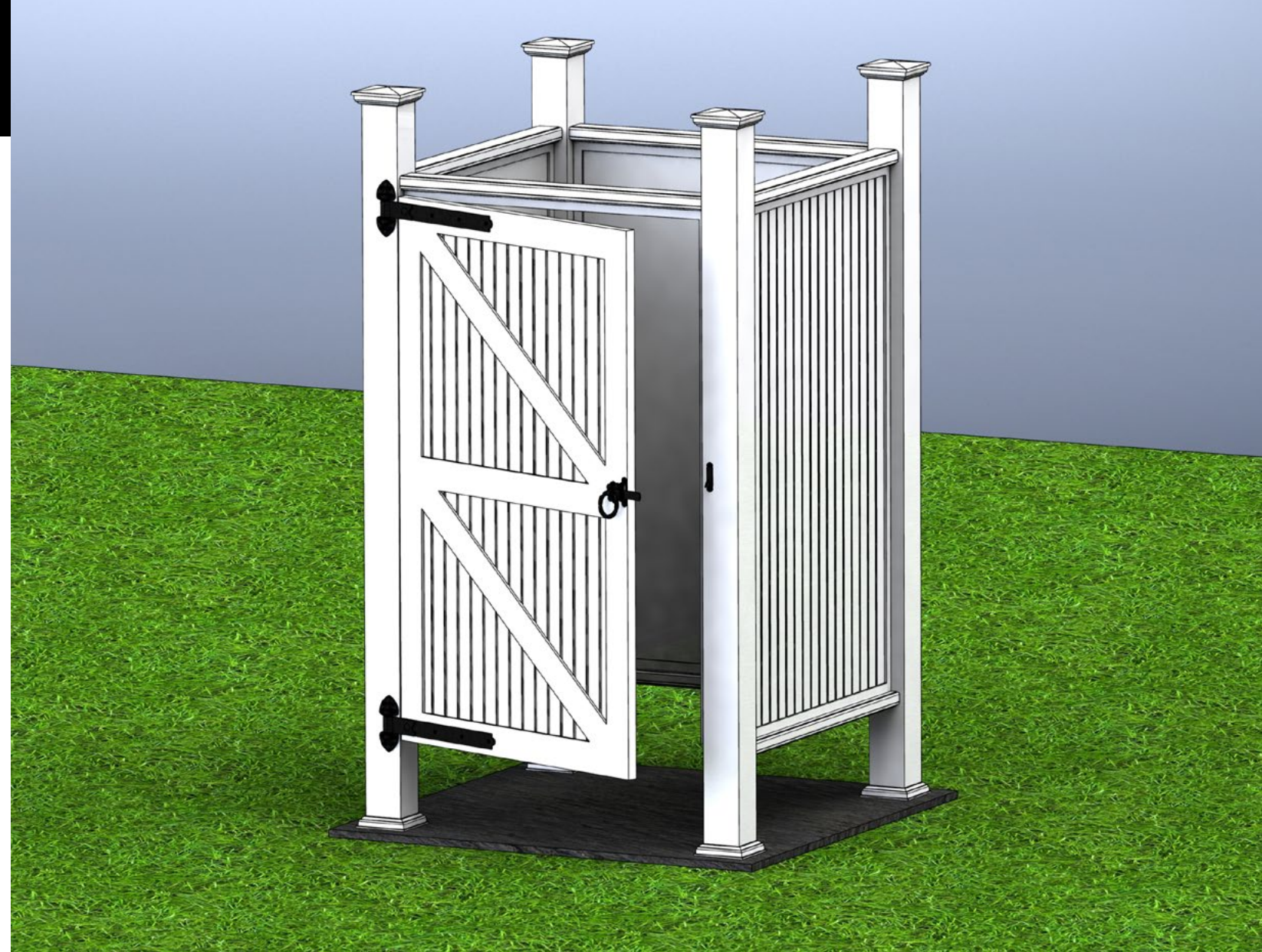

# Shower ENCLOSURES

Complete your outdoor oasis with a low-maintenance Shower Enclosure Kit!

- 100% Cellular PVC
- Available in Open or Closed Back
- Complete Kits Available
- Beaded Detail Wall Panels
- Reinforced Aluminum Core for Strength & Corrosion Resistance
- Low Maintenance and Easy to Clean
- Does Not Require Paint, But Can Be Painted (LRV Greater Than 55)
- For Pricing Information Visit [intexmillwork.com](http://intexmillwork.com)



# Shower Enclosure Kits

4' x 4' Shower Kits	Description
SED-4X4-KIT-OB	Complete Deluxe Open Back Shower Enclosure Kit for a 4' X 4' Foot Print: Includes Four 5" x 93-5/8" PVC Sleeves with caps/trim rings, 2 Deluxe Beaded Shower Panels with assembly hardware, 1 Beaded PVC door with door latch hardware (black hinges, strike & privacy stops), open back. (Customer supplied 4x4's or INTEX structural mounts required)
SED-4X4-KIT-CB	Complete Deluxe Closed Back Shower Enclosure Kit for a 4' X 4' Foot Print: Includes Four 5" x 93-5/8" PVC Sleeves with caps/trim rings, 3 Deluxe Beaded Shower Panels with assembly hardware, 1 Beaded PVC door with door latch hardware (black hinges, strike & privacy stops), closed back. (Customer supplied 4x4's or INTEX structural mounts required)
4' x 8' Shower Kits	Description
SED-4X8-KIT-OB	Complete Deluxe Open Back Shower Enclosure Kit for a 4' X 8' Foot Print: Includes Five 5" x 93-5/8" PVC Sleeves with caps/trim rings, 3 Deluxe Beaded Shower Panels with assembly hardware, 1 Beaded PVC door with door latch hardware (black hinges, strike & privacy stops), open back. (Customer supplied 4x4's or INTEX structural mounts required)
SED-4X8-KIT-CB	Complete Deluxe Closed Back Shower Enclosure Kit for a 4' X 8' Foot Print: Includes Six 5" x 93-5/8" PVC Sleeves with caps/trim rings, 5 Deluxe Beaded Shower Panels with assembly hardware, 1 Beaded PVC door with door latch hardware (black hinges, strike & privacy stops), closed back. (Customer supplied 4x4's or INTEX structural mounts required)

Shower Enclosure Components (A La Carte)	
Posts & Sleeves	Description
NEWEL5108-EX	Extruded 5" Sq X 108" Newel Post Sleeve 3/8" Wall, w/ adjustable Shims (to be field trimmed)
IMPC5	Injection Molded Pyramid Type Cap for 5" Newel Cover
IMTR5	Injection Molded Base Trim for 5" SQ Newel
SSPOST-DOOR	Structural Shower Post for Door Hinge Side. Includes pre-installed nylon glides. Mounting hardware sold separately. (2 Per Door Opening Required)
SSPOST-WALL	Structural Shower Post for Wall Panel Side. Includes pre-installed nylon glides. Mounting hardware sold separately.
NEWELMOUNT-C	Intex Post Mount System, Mounting Hardware for Concrete/Masonry Application
NEWELMOUNT-W	Intex Post Mount System, Mounting Hardware for Wood/Composite Application
Wall Panels	Description
SED-WP-48	Deluxe Shower Beaded Wall Panel. 42-15/16" X 72" (48" Post Centers). Includes upper/lower rails, beaded panel, privacy stops & hardware
SED-WP-19	Deluxe Shower Beaded Wall Panel 14" x 72" (19" Post Centers) Assembly for use as interior partition (requires additional post/sleeve for assembly)
Door Panels	Description
SED-DOOR-48	Deluxe Shower Beaded Door 41 15/16" x 69 5/8" x 2" Assembly w/ Hinges, includes 1 1/4" stops, RS35350 Top Rail, & Stop Screws

**INTERESTED IN PURCHASING INTEX PRODUCTS?**  
Go to [www.intexmillwork.com](http://www.intexmillwork.com) to find an authorized dealer near you!



FIND US ON YOUR FAVORITE CHANNELS  
@intexmillwork | #intexmillwork



## Pergola SYSTEMS

*Freestanding in a garden, gracing a patio or surrounding a hot tub, a pergola creates a dramatic architectural statement. INTEX Pergola Systems are as strong as they are beautiful, and designed for a secure, easy installation. Enjoy your new outdoor oasis in as little as a weekend.*

- Aluminum Reinforced Cellular PVC Components
- Complete Bracket System for Easy Installation
- Low Maintenance
- Cellular PVC Components Will Not Rot, Warp, Crack, or Peel
- Aluminum Reinforcements and Brackets will not Rust or Corrode
- Quality Stainless Steel Screws and Fasteners Will Not Rust or Bleed onto the Structure
- Pergola Systems Engineered to Meet International Building Code Are Available
- Economical Pergola System Kits Available
- Multiple Standard Pergola Tail Designs



Pergola Systems Comparison

	Classic Kit	Deluxe	Premium	Custom *
Rafter Options	1	1	2	3
Beam Options	1	1	4	4
Maximum Clear Spans	14' x 14'	14' x 14'	25' x 25'	25' x 25'
Design Strength	★★★	★★★★	★★★★★	★★★★★★
Custom Lengths		●	●	●
Custom Design Options		●	●	●
Standard Tail Designs	4	6	9	9
Custom Tail Designs			●	●
Engineered to International Building Code Requirements			●	●
Bend to Radius				●
Price	\$	\$\$	\$\$\$	\$\$\$\$

\* INTEX Millwork Solutions Custom Pergola option is available for projects that need to go beyond the limits of the Premium Pergola System.

Classic Kit Standard Tail Designs

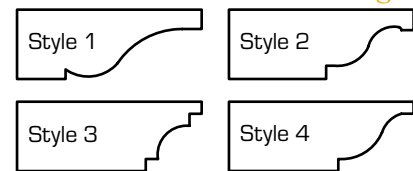

Deluxe Standard Tail Designs

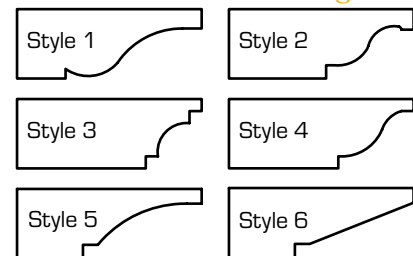

Premium Standard Tail Designs

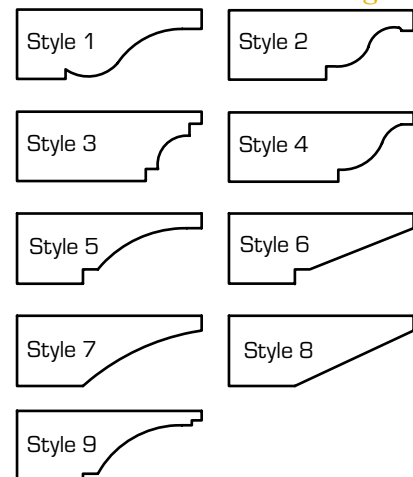

**Exceptional Strength and Durability**  
 INTEX cellular PVC pergola components are sleeved over structural aluminum internal reinforcements to provide strength and durability. Additionally, INTEX has designed a complete bracket system for assembling components together. Bracket holes align the screws with the internal aluminum members, assuring a secure installation.

Custom Pergola Pictured

Common Questions

**WHAT ARE THE BENEFITS OF CELLULAR PVC?**

INTEX's Cellular PVC millwork offers durability that far surpasses wood or other materials. While wood can be affected by moisture, changing temperatures, UV light and insects, INTEX's Cellular PVC is just the opposite. Our Cellular PVC is impenetrable to moisture and it won't rot, swell or split like wood. INTEX's Cellular PVC is bug proof, UV resistant and impervious to salt. Unlike Vinyl, INTEX's Cellular PVC can be milled, painted, and installed like natural lumber. INTEX's Cellular PVC also does not squeak, shine, yellow, fade, or chalk like vinyl.

**CAN INTEX PRODUCTS BE PAINTED?**

Yes, due to the inherent expansion and contraction characteristics of PVC, INTEX's PVC millwork products should only be painted colors with an LRV (light reflective value) greater than 55.

**HOW DO YOU CLEAN CELLULAR PVC?**

Cleaning all INTEX products are easy and fast with most major household cleaners. There are many cleaners on the market and the glass cleaners seem to be the best candidate for keeping the finish looking great. The cleaning solution should be applied and immediately wiped dry. Harsh cleaners with glycol ethers or ethanol type solvents and/or isopropyl alcohol are not recommended.

**HOW LONG DO INTEX PRODUCTS LAST?**

INTEX products are designed to last in the harshest of environments. For this reason, all INTEX Millwork Solutions products carry a lifetime limited warranty.

**WHERE CAN I PURCHASE INTEX PRODUCTS?**

Go to [www.intexmillwork.com](http://www.intexmillwork.com) to find an authorized dealer near you.

**ARE TECHNICAL DRAWINGS AND DOCUMENTATION OF INTEX PRODUCTS AVAILABLE?**

Technical drawings and product documentation are available on [www.intexmillwork.com](http://www.intexmillwork.com). If you need more information, please call our office at (856) 293-4100.

**ABOUT THE FRONT COVER**

Thank you to Atlantic Fence Supply (MA) for the front cover image!

*Lifetime Limited Warranty*

All INTEX Millwork Solutions products carry a lifetime limited warranty. Please see our web site for further information.

Made in U.S.A  
 Copyright © 2019 INTEX Millwork Solutions, LLC





# INTEX<sup>®</sup>

MILLWORK SOLUTIONS

Welcome to INTEX Millwork Solutions, where we are leveraging world-class engineering and design to develop inventive and beautiful architectural solutions for all of your projects, every time.

As one of the first companies to offer aluminum-reinforced, cellular PVC millwork, INTEX Millwork Solutions enables architects, builders, and contractors to anticipate and deliver on their customers' vision for their homes, no matter how grand.

If you'd like to learn more about INTEX Millwork Solutions, visit [intexmillwork.com](http://intexmillwork.com) or give us a call. We'll be happy to answer your questions, assist you in selecting options, or work with you in creating a custom design.

---

**INTEX Millwork Solutions, LLC**  
45 Mill Street • Mays Landing, NJ 08330  
(856) 293-4100  
[intexmillwork.com](http://intexmillwork.com) | [#intexmillwork](https://twitter.com/intexmillwork)

© 2019, INTEX Millwork Solutions, LLC

2019-Fence-1 Printing